



## SEALING PLUGS



## General information

### Product description

The PSI plug is a sealing device consisting of two half shells. It is especially designed to seal cables and pipes passing through walls and ceilings. Due to the large variety of sizes and rubber types, you can use this sealing plug for almost any pipe or cable. The installation is fast and simple and can be done without the use of special tools as the plug is just hammered in the annular space. The profiled design of the plug makes installation easy and ensures a pressure tightness up to 3 bar.

The relevant test certificates are available. All PSI plugs are manufactured from high quality rubber and are highly resistant to abrasion. We can supply plugs with five different rubber types to ensure suitability for all industry sectors, such as construction, marine power and offshore.

### Advantages

- pressure tight up to 3 bar
- easy installation
- large range of application
- noise absorbing
- fire retarding qualities
- vibration absorbing
- no electrical conduit
- high resistance to abrasion
- can be installed horizontally and vertically
- several rubber qualities with chemical resistance

CERTIFICATES		
Application	Certified by	Value
Pressure	Lloyd's	3 bar
Fire/construction	Warrington	120 minutes
Fire/construction	Warrington	60 minutes
(PVC pipes)		60 minutes
Fire/marine	IMO Regulations	60 minutes

## Application range

### Sealing a wall opening

The plug can be used in a core drilled hole if the surface is in a good shape. The plug is hammered in the annular space from the outside of the wall. A pressure tightness of 3 bar can be achieved. The plug can also be used in wall sleeves of different materials (PVC, ASTM, DIN...)

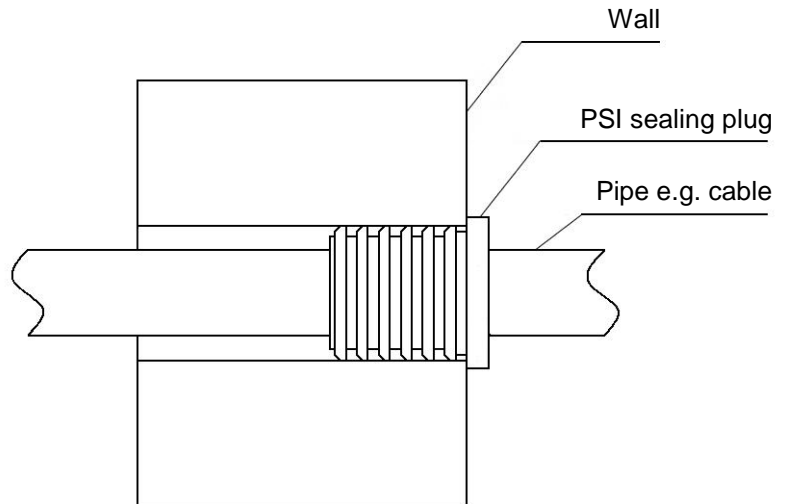



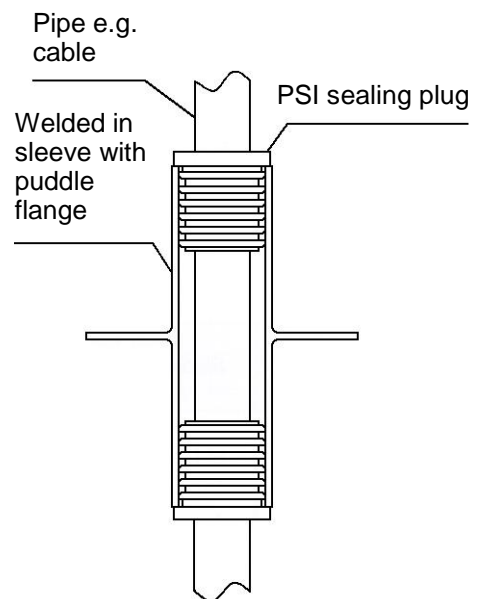
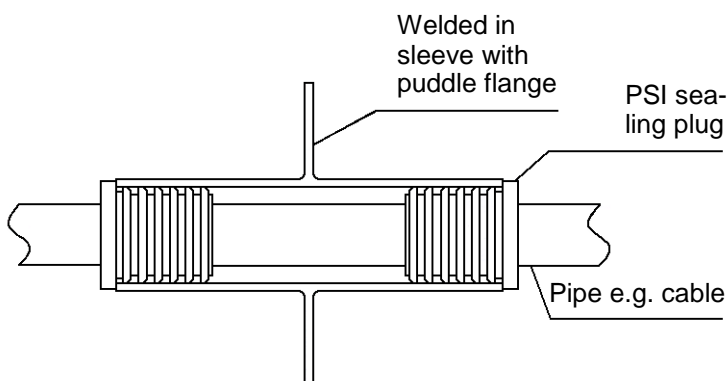

### Sealing in ship building industry

The plugs are installed from both sides in a welded sleeve situated in a wall or a deck. In these cases you will use the high fire retardant rubber FS. Fire resistance of 60 minutes was tested and certified according to the IMO Fire Test Procedure Code Annex 1, part 3. The welded in sleeve will then be wrapped with rockwool.



### Selection of types and rubber quality

For use in core drilled holes/aluminium sleeves			
Core drilled hole I.D. mm	Pipe/cable mm	Core drilled hole I.D. mm	Pipe/cable mm
40	16	100	32
43,60	12	100	40
50	Without hole	100	50
50	15	100	54
50	28	100	62
50	32	102,3	40
54,5	18	103,6	32
54,5	32	103,6	40
60	32	103,6	50
60	40	125	74
70	40	150	90
70	50	150	110
80	30	150	114
80	32	200	160
80	40		
80	44		
94	32		
94	40		
94	50		

Rubber quality				
	Material	Colour	Temperature range	Characteristics
	EPDM	Black	-25°C / +110°C	Standard rubber for gas and water tight sealings
	Nitrile	Blue	-25°C / +110°C	Resistant to hydrocarbons and greases
	FS	Red	-30°C / +120°C	Highly retarding rubber
	Silicone	Brown	-60°C / +200°C	For high/low temperatures
	Viton	Green	-25°C / +200°C	High resistance against chemicals

## How to find the right type

### 5 steps to find the right type of PSI plug

#### 1. Find out which kind of wall opening you have?

The cable/pipe will be passed through which sleeve or core drilled hole?

- PVC-sleeve
- Core drilled hole/aluminium sleeve (DH-AP)
- DIN Steel sleeve
- ASTM sleeve

#### 2. Determine the I.D. of the opening

It is very important to check the exact I.D. of the opening as this corresponds to the O.D. of the PSI sealing plug. Example: PVC sleeve diameter 110 mm with a wall thickness of 3,2 mm. The I.D. will be 103,6 mm. This is also the O.D. of the correct sealing plug.

#### 3. Determine the O.D. of the cable or pipe

The O.D. of the cable or pipe corresponds to the I.D. of the sealing plug. The diameter can be rounded down to whole millimeters. For example 20,6 = 20 mm. By doing this you ensure a safe and correct sealing. The PSI sealing plug systems shows a minimum to maximum opening range per diameter. This range shows the smallest possible pipe/cable and the largest one. For the serial 103,6 mm the smallest is 30 mm and the largest is 74 mm.

#### 4. Which rubber is the right one?

The PSI sealing plug is available in 5 rubber qualities. EPDM for standard applications in the gas and water, Viton for chemicals resistance ect.

#### 5. Summary

The description of the PSI sealing plug consists of 3 elements:

1. I.D. of the core drilled hole or sleeve = Dimension indicated on the plug
2. O.D: of the cable or pipe
3. Rubber quality

Example: You have a pipe with an O.D. of 50 mm and a PVC sleeve (diam. 110 mm). The sealing shall be gas and water tight: 103,6/50 EPDM.